

### LAMELKA L-1

GŁĘBOKOŚĆ WYBRANIA - 3 mm

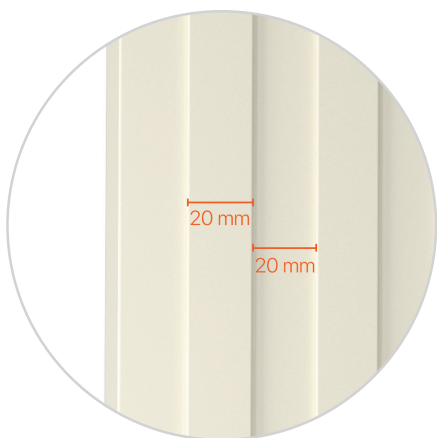

### LAMELKA L-2

GŁĘBOKOŚĆ WYBRANIA - 3 mm

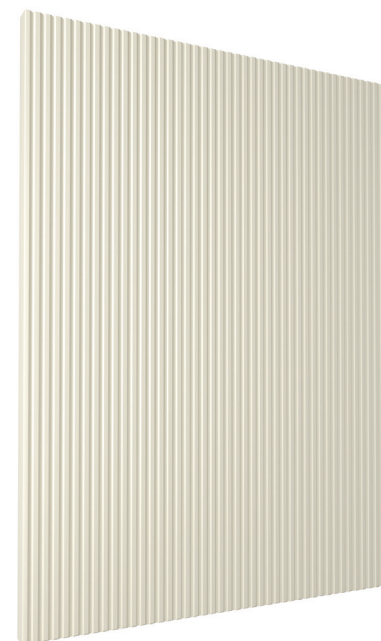
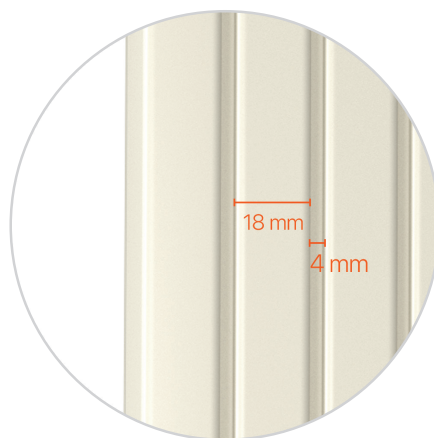

### LAMELKA L-3

GŁĘBOKOŚĆ WYBRANIA - 2 mm

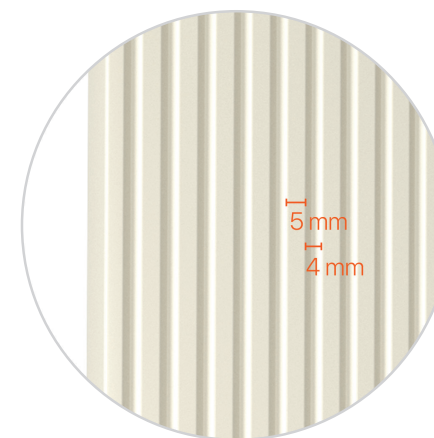



### LAMELKA L-4

GŁĘBOKOŚĆ WYBRANIA - 3 mm

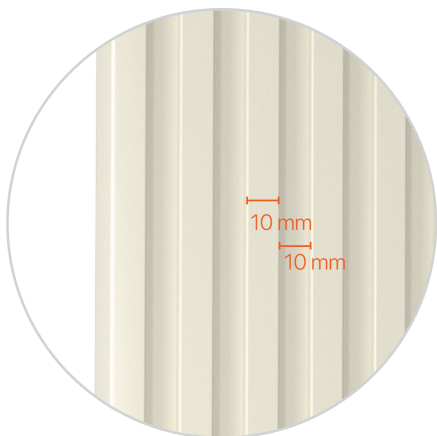

### LAMELKA L-5

GŁĘBOKOŚĆ WYBRANIA - 6 mm  
STANDARDOWA GRUBOŚĆ - 22 mm

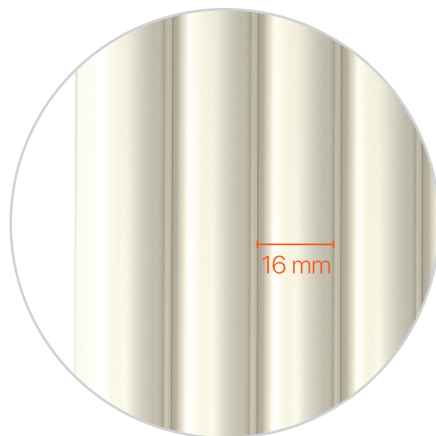

### JODEŁKA

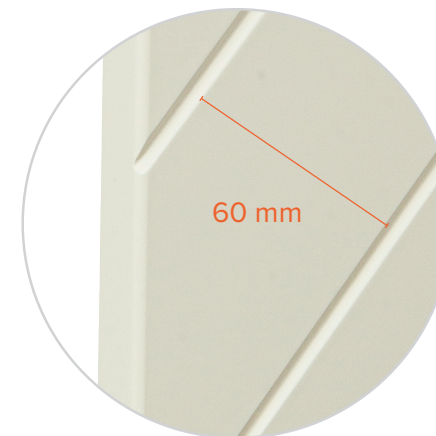

# FRONTY RAMOWE

MBS/R2

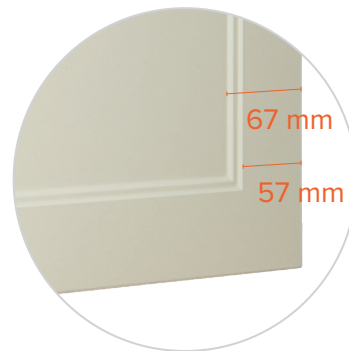

BARSAK/R2

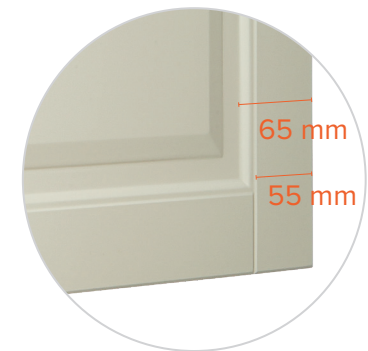

P/5/R2

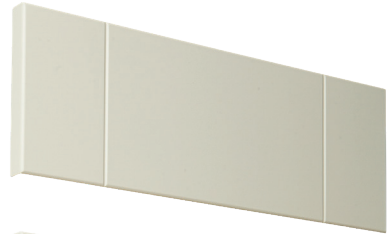

PR/6/R2

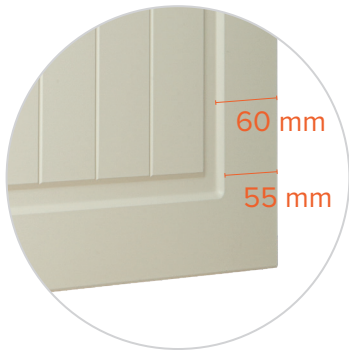

PR/9/R2

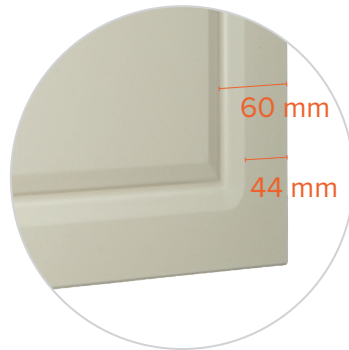

PR/10/R2

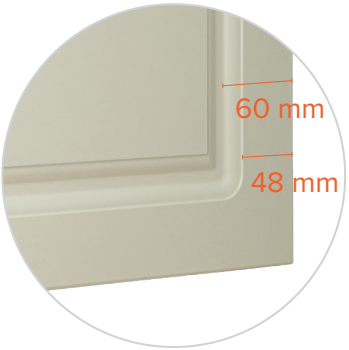

PR/11/R2

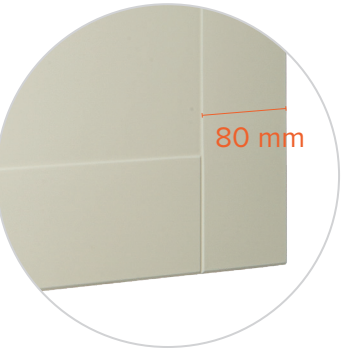

PR/20/R2

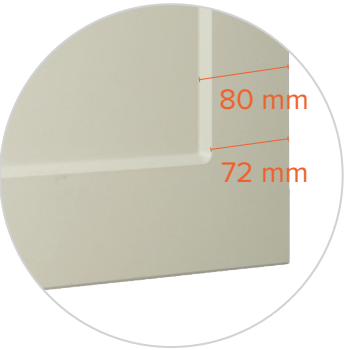

PR/21/R2

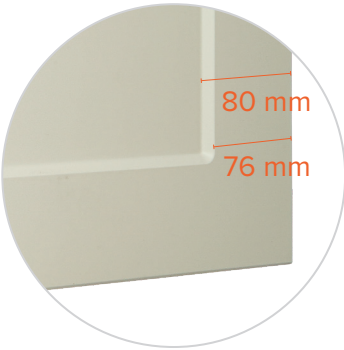

PR/33/R2

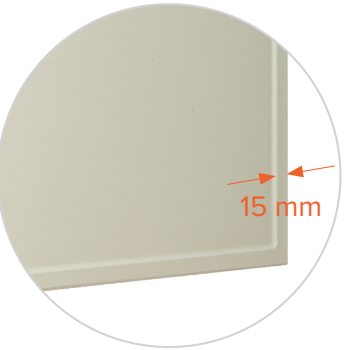

PR/50/R2

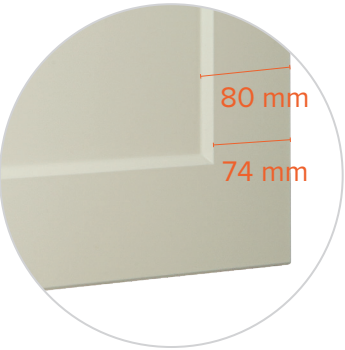

PR/51/R2



GLOBAL/R2



AVINA/R2

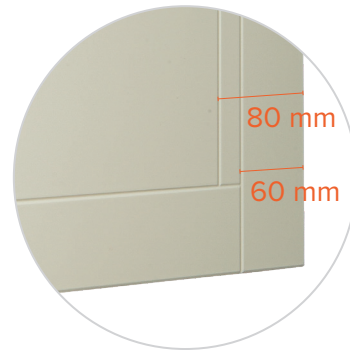

LOTUS/R2

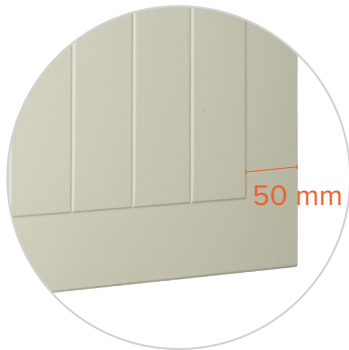
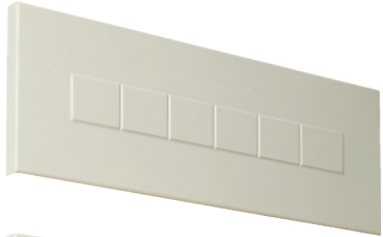

MEFO/R2



S1/RAJO/R2

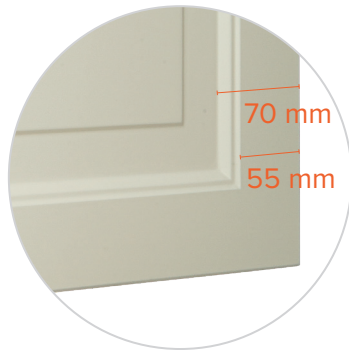

P/3/MSM



GRZEŚ/R2

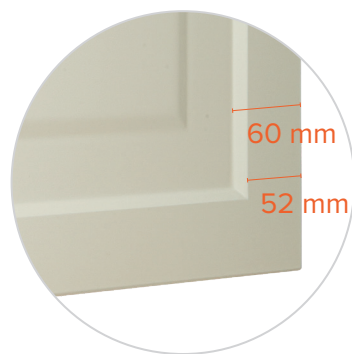

MEGAN/R2

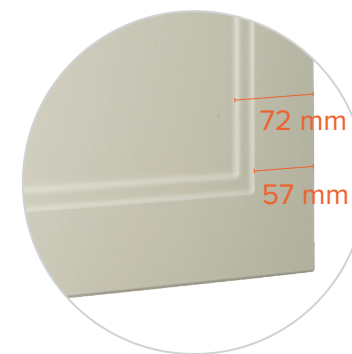

**MARYSIA/R2**

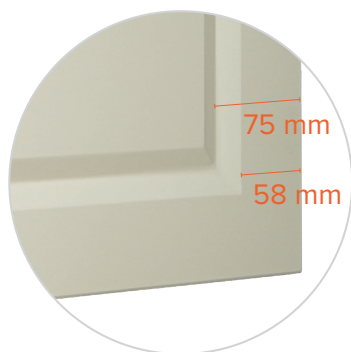

**RAMONA/R2**

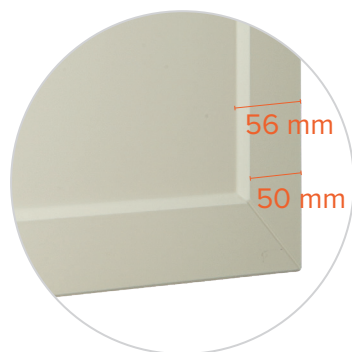

**KEG/R2**  
STANDARDOWA GRUBOŚĆ: 22 mm

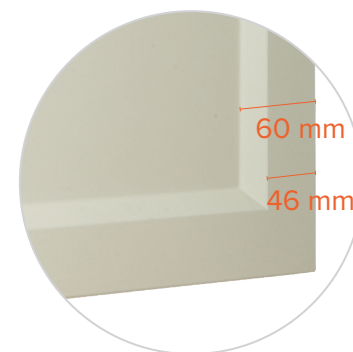



WITRYNY

WITRYNA W1



WITRYNA W2

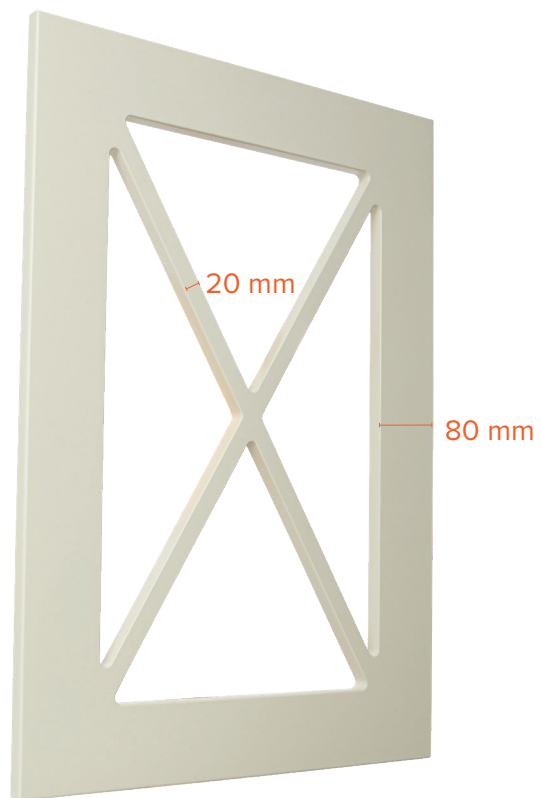

WITRYNA W3\*

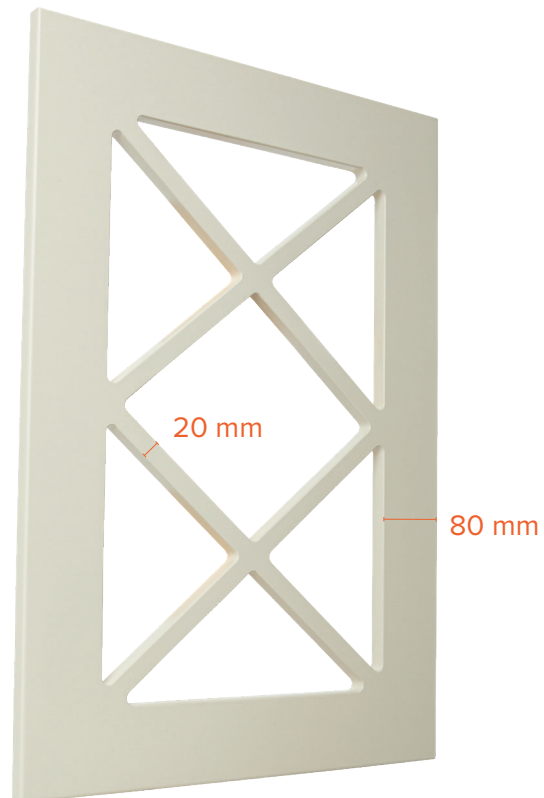

WITRYNA W4\*

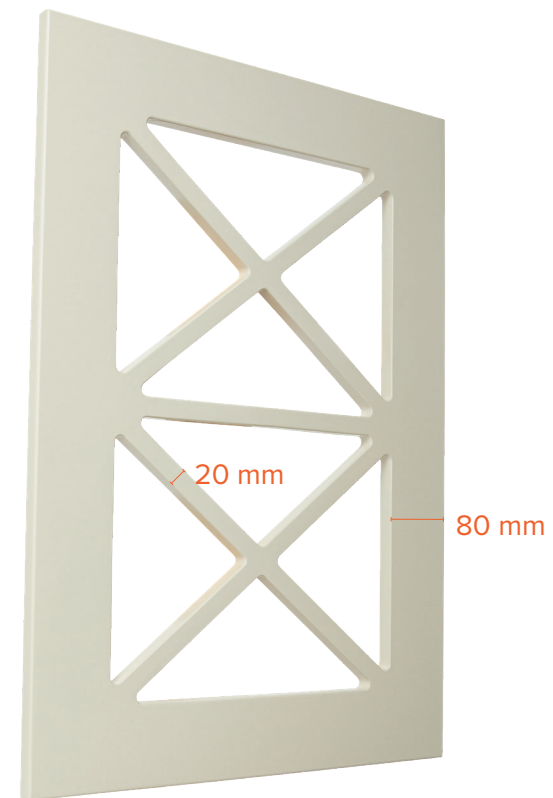

WITRYNA W5\*

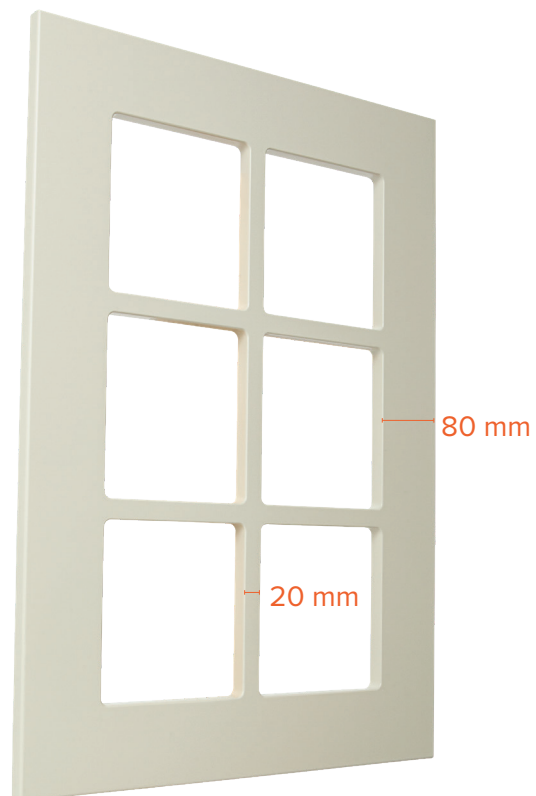

WITRYNA W6\*



WITRYNA W7



\*- zdjęcie poglądowe. Przy składaniu zamówienia należy podać ilość okienek.

UCHWYTY  
FREZOWANE

UCHWYT „A”

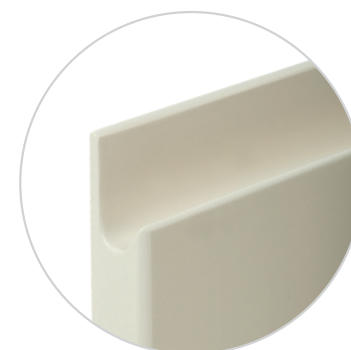

UCHWYT „B”

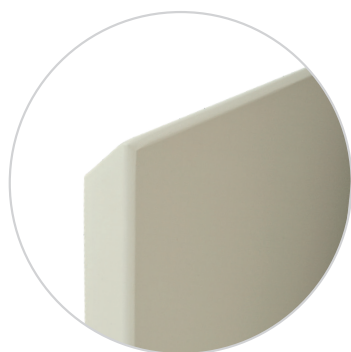

UCHWYT „C”



UCHWYT „E”



UCHWYT „F”



UCHWYT „UKW5”

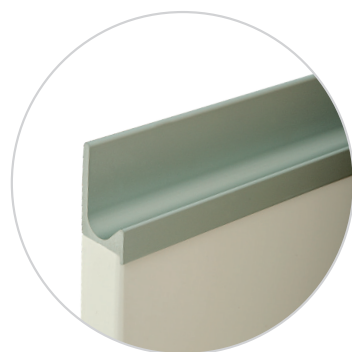

UCHWYT „UKW7”

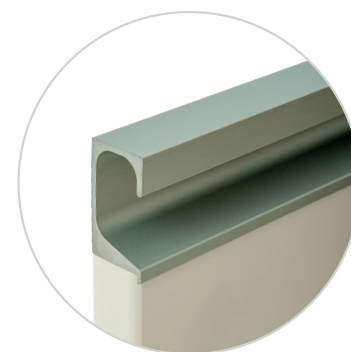

PILASTRY  
LISTWY  
WIEŃCZĄCE

PILASTER P1

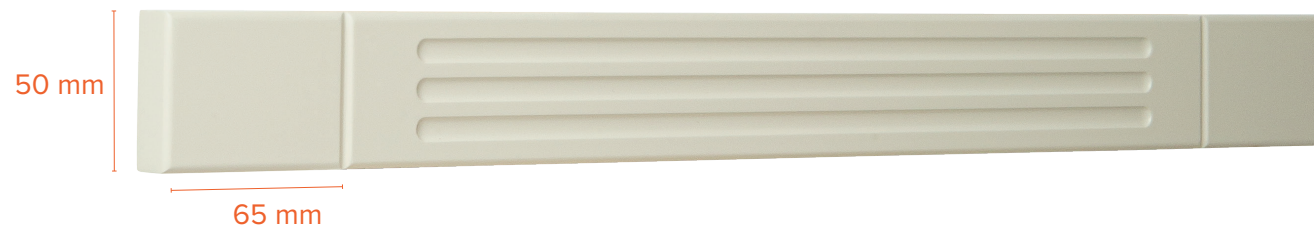

PILASTER P2



PILASTER P3



### LISTWA LW13

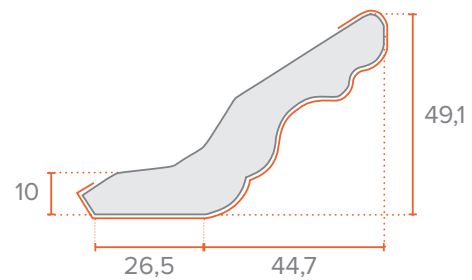
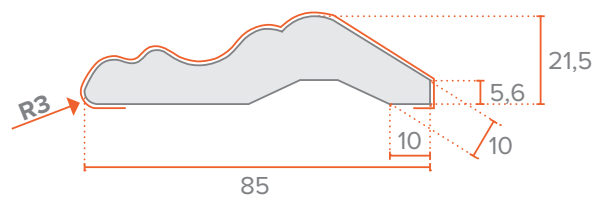

### LISTWA LW16

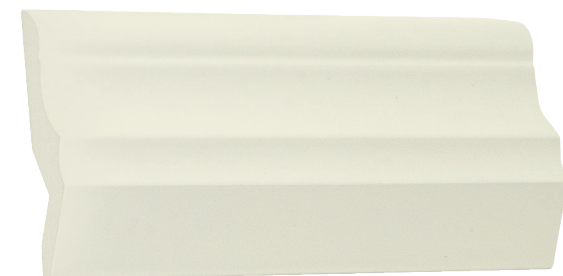
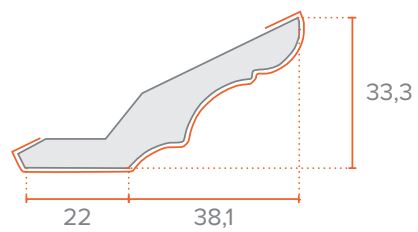
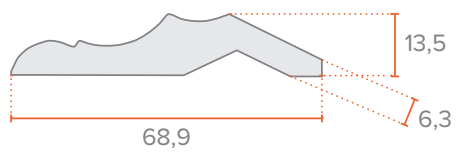

## LISTWA LW25

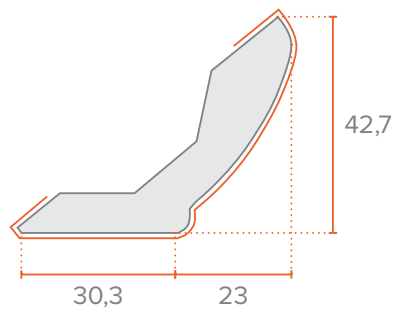
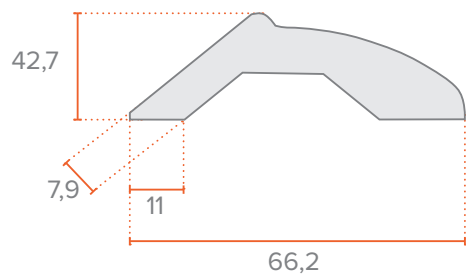

## LISTWA LW27

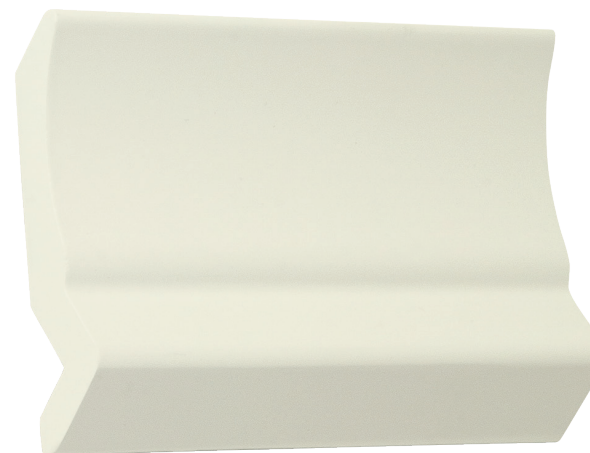
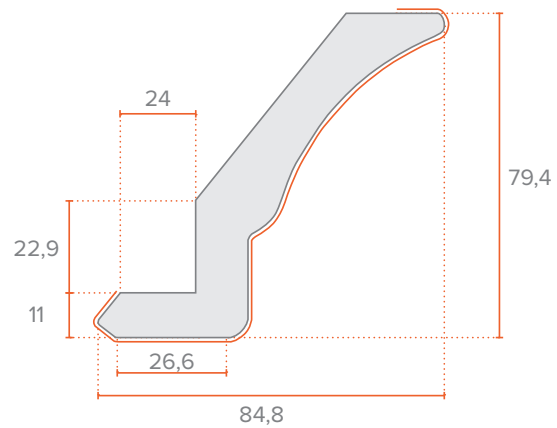
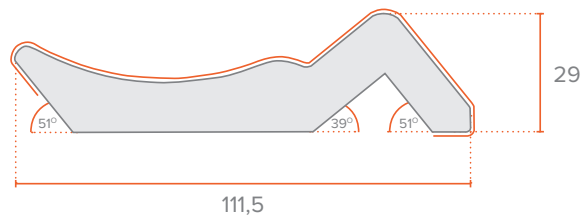

## INFORMACJE TECHNICZNE

- < Pracujemy na wzornikach - **RAL K7, NCS, ICA.**
- < Standardowa grubość frontów wynosi **18 mm.**
- < Dostępne grubości w MDF:  
**10 mm, 16 mm, 18 mm, 22 mm, 28 mm, 38 mm, 50 mm.**
- < Uchwyt występuje **w standardzie po szerokości.**
- < Dostępne trzy wykończenia powłok: **połysk, mat, velvet.**  
Brak określenia, skutkuje wykonaniem **w połysku.**
- < Standardowa krawędź frontów gładkich i ramiakowych to **R2.**  
Możliwość indywidualnego doboru frezowania.  
Frezy obwiedniowe do wyboru: R1, R2, R5, R10, M, MS2, MS5, MSM.
- < Dostępny **maksymalny wymiar** frontu, wykonanego przy użyciu maszyny CNC wynosi **2800x1200 mm.**
- < Wszystkie zamówienia powinny być rozpisywane na naszym oryginalnym arkuszu zamówieniowym. Klienci, którzy nie stosują się do powyższego, muszą liczyć się z faktem, iż w przypadku błędnego przepisania zamówienia przez dział handlowy, ewentualna reklamacja nie będzie uwzględniona.
- < Przy lakierowaniu lewej strony matem, niemożliwe jest wykonanie zaoblenia krawędzi.



NINIEJSZA INFORMACJA NIE STANOWI OFERTY HANDLOWEJ W ROZUMIENIU KC.  
PRODUCENT ZASTRZEGA SOBIE PRAWO DO WPROWADZENIA ZMIAN BEZ UPRZEDNIEGO O NICH POINFORMOWANIA ZAINTERESOWANYCH STRON.